

特点 Features

- 低线圈功耗。
Low coil power consumption .
- 超小型，标准印刷板引出脚。
Micro-miniature relay, standard PCB terminals.
- 符合欧洲 RoHS 及白色家电要求。
Compliance EU RoHS and the requirement of white home appliances.
- 可提供满足雷击耐压 ≥ 6000 的产品。
Impulse withstand voltage $\geq 6000V$ product is available.
- 可提供满足 IEC60335-1 GWIF 850°C/ GWIF 775°C 和 CTI $\geq 250V$ 的产品。
IEC60335-1 GWIF 850°C/ GWIT 775°C and CTI $\geq 250V$ compliant product is available.
- 可提供满足 IEC60079-15 的产品。
IEC60079-15 compliant product is available.

安规认证 Safety certificate

UL、c-UL 认证号 (File No.) : E190598

CQC 认证号(File No.) : CQC02001002126、CQC10002050459、
CQC21002306489

VDE 认证号 (File No.) : 40034479

触点参数 Contact Data

型号 Type	SRDI
额定负载 (阻性负载) Rated load (Resistive load)	10A 250VAC
最大切换电流 Max. switching current	15A
最大切换电压 Max. switching voltage	250VAC
最大切换功率 Max. switching power	2,500VA
最小切换负载 Min. switching load	6V 1A

性能参数 Characteristic

触点材料 Contact material	银合金 Silver alloy	
接触电阻 Contact resistance	100mΩ Max. (at 1A 6VDC)	
吸合时间 (额定电压) Operate time (at rated coil voltage)	8ms Max. (不加二极管 No diode)	
释放时间 Release time	5ms Max. (不加二极管 No diode)	
绝缘电阻 Insulation resistance	Min. 1,000MΩ (at 500VDC)	
介质耐压 Dielectric strength	触点与触点间 Between open contacts : 750VAC, 50/60Hz for 1min.	
	触点与线圈间 (Between coil and contact) : 标准品 standard product: 2,500VAC ,50/60Hz for 1min.	
	品名后缀有"-6"标示产品 product with suffix "-6" :; AC 3,000 V, 50/60Hz for 1min.	
冲击耐压 Impulse withstand voltage	触点与线圈间 (Between coil and contact) : 标准品 standard product: ≥4,800V 1.2/50 us	
	品名后缀有"-6"标示产品 product with suffix "-6": ≥6,000V 1.2/50 us	
抗振动 Vibration resistance	耐久 Destructive	10 ~ 55Hz , 双振幅 1.5 mm 10 ~ 55Hz, at double amplitude of 1.5mm
	误动作 Functional	10 ~ 55Hz , 双振幅 1.5 mm 10 ~ 55Hz, at double amplitude of 1.5mm
抗冲击 Shock resistance	耐久 Destructive	100G Min.
	误动作 Functional	10G Min.
寿命 Endurance (operations)	机械寿命(每小时 10,800 次, 室温) Mechanical endurance (at 10,800ops./h)	10,000,000 次 10,000,000(at room temperature)
	电气寿命(每小时 360 次, 室温) Electrical endurance (at 360ops./h)	100,000 次 100,000(at room temperature)
环境温度 Ambient temperature	-40°C ~ +85°C (不冷凝 No condensation) 若需要 105°C产品, 请联系三友 For ambient temperature is 105°C, please contact Sanyou	
重量 Weight	约 8.5g Approx. 8.5g	

线圈参数 Coil Data (at 20°C)

额定电压 (VDC) Nominal voltage (VDC)	额定电流 ±10%(mA) Nominal operating current ±10%(mA)	线圈电阻 ±10% (Ω) Coil resistance ±10%(Ω)	最大连续外加电压 Max. allowable voltage	吸合电压 (Max.) Operate voltage (Max.)	释放电压 (Min.) Release voltage (Min.)	额定功率 Nominal operating power
3	120.00	25	130% of nominal voltage	75% of nominal voltage	10% of nominal voltage	0.36W
5	71.42	70				
6	60.00	100				
9	40.00	225				
12	30.00	400				
15	24.00	625				
18	20.00	900				
24	15.00	1,600				
48	7.50	6,400				
60	6.00	10,000				

上述值为初始值；请勿在产品上连续施加最大电压 > 10min，以免线圈过度发热。

The data shown above are initial values. Do not apply maximum allowable voltage on coil for more than 10 minutes to avoid overheating of the coil.

安规认证负载（注：更多详细的认证负载，参考安规证书）

Safety Certificate Ratings (Note: More details of approved ratings, please refer to the safety certificates)

认证类型 Certificates	CQC	VDE	UL/CUL	TUV
认证号码 File No.	CQC02001002126 CQC10002050459 CQC21002306489	40034479	E190598	R50142424
认证负载 Approved Ratings	10A 250VAC 7A 250VAC 5A 240VAC	10A 250 VAC 7A 250 VAC	12A 125VAC, Resistive, 15A 125VAC, Resistive, 10A 250VAC, Resistive, 7A 250VAC, General use, 1/3 HP 250VAC, FLA 5A, LRA 10A, 120/240VAC, TV-5, 120VAC.	10A 250 VAC 7A 250 VAC

(1) 上述未注明温度的负载，均指环境温度为室温。

All values unspecified are at room temperature

(2) 以上仅列出了该产品认证的部分负载，每个负载的详细测试条件不同，因此电寿命次数不一样。如需了解详细情况，请联系三友。

Only typical ratings are listed above and the endurance differ in each load. Other specific load information are available upon request.

(3) 对于塑封式、防水式产品试验时，应打开外壳的透气孔。

For sealed type testing, please open the ventilation hole in the case before test.

订货标记 Ordering Information

型号命名规则 Nomenclature

SRDI -S -1 12 D M 6 -F -XX

特殊参数 Special Parameter :

无-标准型, 6-6000 冲击耐压, 字母或数字-特殊要求
Nil-Standard type, 6-6000V impulse withstand voltage,
Letter or number-Special requirement

绝缘等级 Insulation System :

无 Nil - 普通型 Standard, B - Class B, F - Class F

触点材质 Contact Material :

Nil & 2 -AgSnO₂
4 - 三复合 (3 Compounds) AgSnO₂ (Form C)
5 - 铜镀镧 Cu plated with La
6 - AgNi
7 - AgNi & AgSnO₂
8 - 三复合 (3 Compounds) AgNi (Form C)

触点形式 Contact Form : Nil - Form C, B - Form B, M - Form A

线圈功耗 Coil power : D-0.36W

线圈电压 Rated coil voltage(VDC) :

03, 05, 06, 09, 12, 15, 18, 24, 48, 60

触点组数 Number of poles : 1-1Pole

封装形式 Protective construction :

S-塑封式 Flux-proof

SH-防水式 Sealed type washable

基本型号 Type : SRDI

- (1) 塑封式不能在污染环境 (含有 H₂S、SO₂、NO₂、粉尘等污染物) 中使用。
Flux-proofed relays can not be used in the environment with pollutants like H₂S, SO₂, NO₂, dust, etc.
- (2) 塑封式装入 PCB 焊接后, 不能进行整体清洗或表面处理。
Water cleaning or surface process is not suggested after the flux-proof relays are assembled on PCB.
- (3) 客户特殊要求 (XX), 由我司评估后, 按特性符号标识。
The customer special requirement express as special code after evaluating by Sanyou.
- (4) 外壳印字需要印 VDE 安规的, 只有 "D" "D2" "D3" "D6" "DM" "DM6" 这六种规格产品。
The "VDE" printing on the cover are only available for products with the suffixes of "D" "D2" "D3" "D6" "DM" "DM6" .

外形尺寸图、接线图、安装孔位图 (单位: mm)
Outline dimension, wiring diagram, PCB layout (Unit: mm)

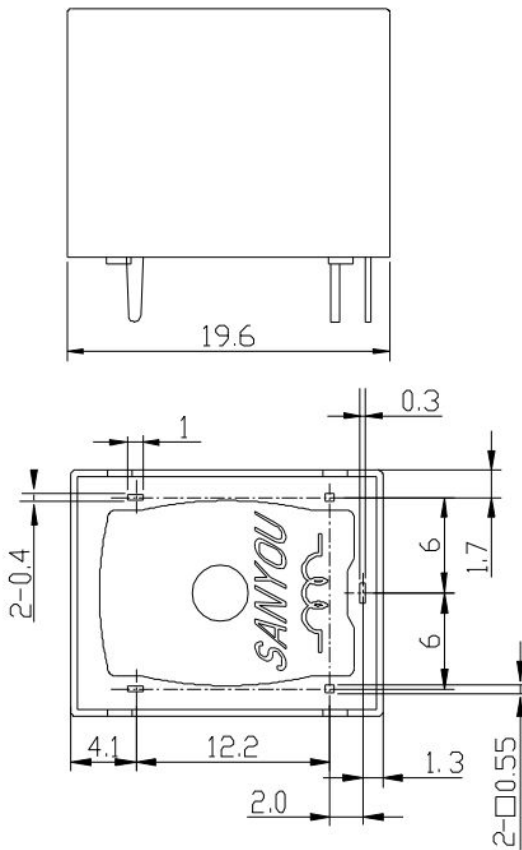

未标注尺寸公差

In case of no tolerance shown on outline dimension

If dimension < 1 mm, tolerance : ±0.2mm

If dimension 1~5mm, tolerance : ±0.3mm

If dimension > 5mm, tolerance : ±0.4mm

注 Note :

1.引出脚尺寸为预焊前尺寸

The dimension of pin is the size before tinning

2.安装孔尺寸公差 : ±0.1mm

Tolerance of PCB layout : ±0.1 mm.

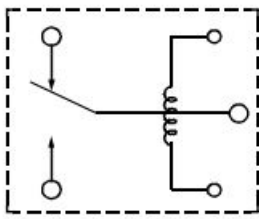

1c

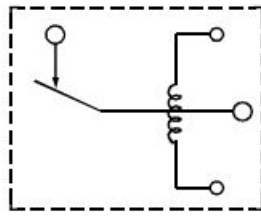

1b

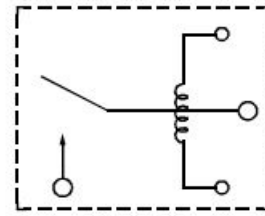

1a

接线图 (底视图)

Wiring Diagram (bottom view)

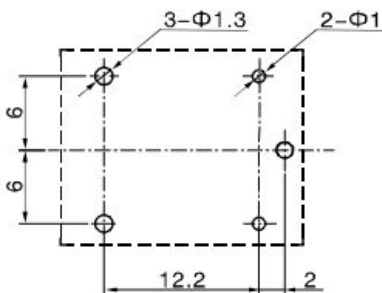

1c

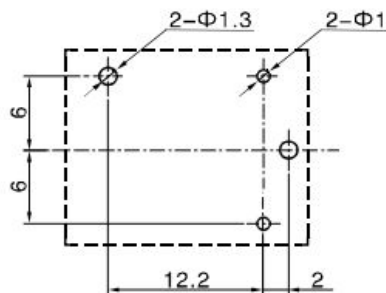

1b

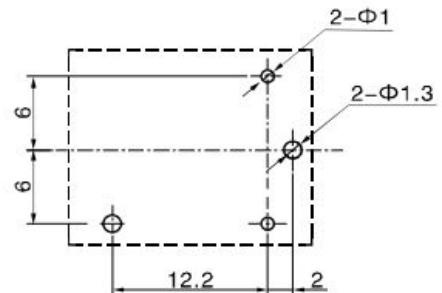

1a

安装孔位图 (底视图)

P.C.B Layout (bottom view)

典型用途 Typical Applications

- 家用电器：空调、电热器等 Home appliances such as air conditioner, heater, etc.
- 自动售货机 Automat.
- 办公设备：电脑、传真机等 Office equipment such as computer, fax machine, etc.
- 自动电控窗、汽车天线、门锁等 Utomatic eletric controlled window, car antenna, door lock, etc.

性能曲线图 Characteristic Curves

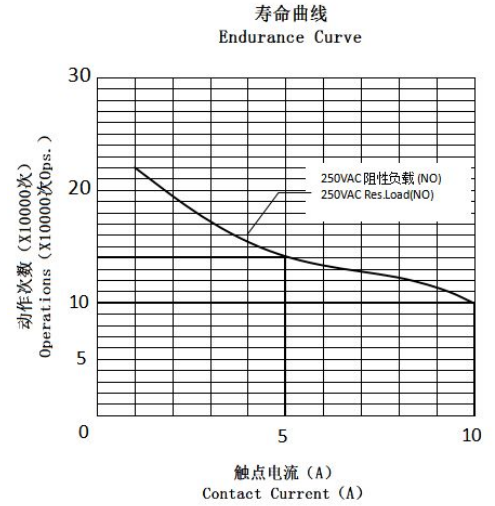
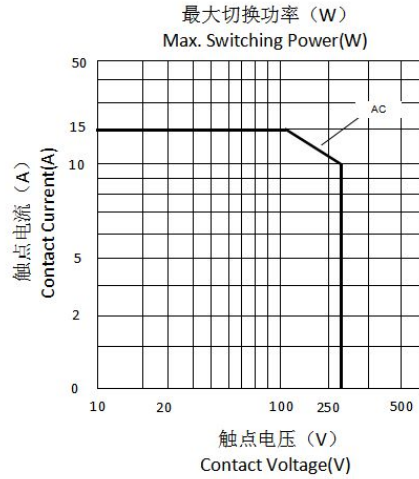
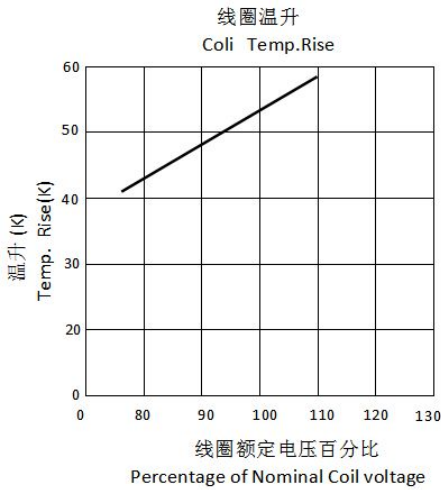

备注 Note:

(1)测试条件：常温环境，开孔品，阻性负载，1s 通 9s 断
Test conditions: room temperature, flux-proof product, resistive load, 1s on, 9s off.

(2)以上曲线图仅供参考，最终结果以实验测试为准

The above curves are for reference only, and the final result is subject to the experiment.

声明：本产品规格书仅供客户使用时参考，若有更改，恕不另行通知。

对三友而言，不可能评定继电器在每个具体应用领域的所有性能参数要求，因而客户应该根据具体的使用条件选择与之相匹配的产品。对于密封继电器在安装清洗后，使用前请打开外壳上的透气孔。若有疑问，请与三友联系获取更多的技术支持。但产品选型责任仅由客户负责。

Disclaimer : The specification is for reference only. Specifications are subject to change without prior notice.

We could not evaluate all the performance and all the parameters for every possible applications. Thus the users should in a right position to choose suitable product for their own application. For sealed relays, after installation and cleaning, please open the ventilation hole in the case before use. If there is any query, please contact Sanyou for technical services. However it is the user's responsibility to determine which product should be used.